

ASSEMBLY INSTRUCTIONS FOR #31970 (SF1-TR546-08R-1)

IMPORTANT
TURN OFF THE POWER AT THE MAIN
FUSE OR CIRCUIT BREAKER BOX
BEFORE STARTING INSTALLATION

CAREFULLY UNPACK AND IDENTIFY ALL
PARTS BEFORE ASSEMBLY. BULBS ARE
NOT INCLUDED

1. Attach crossbar to outlet box with screws provided. FIG.A
2. Wire fixture to home supply wires as per local elec. code. FIG.A
3. Attach fixture to crossbar with fixture screws. FIG.A.

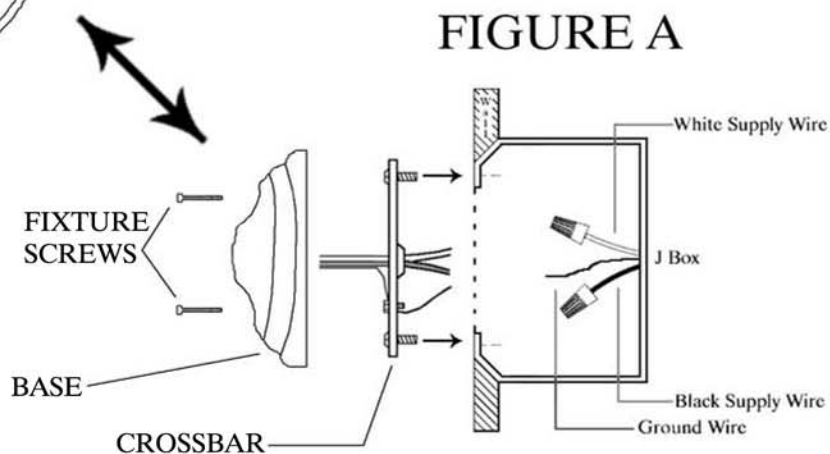
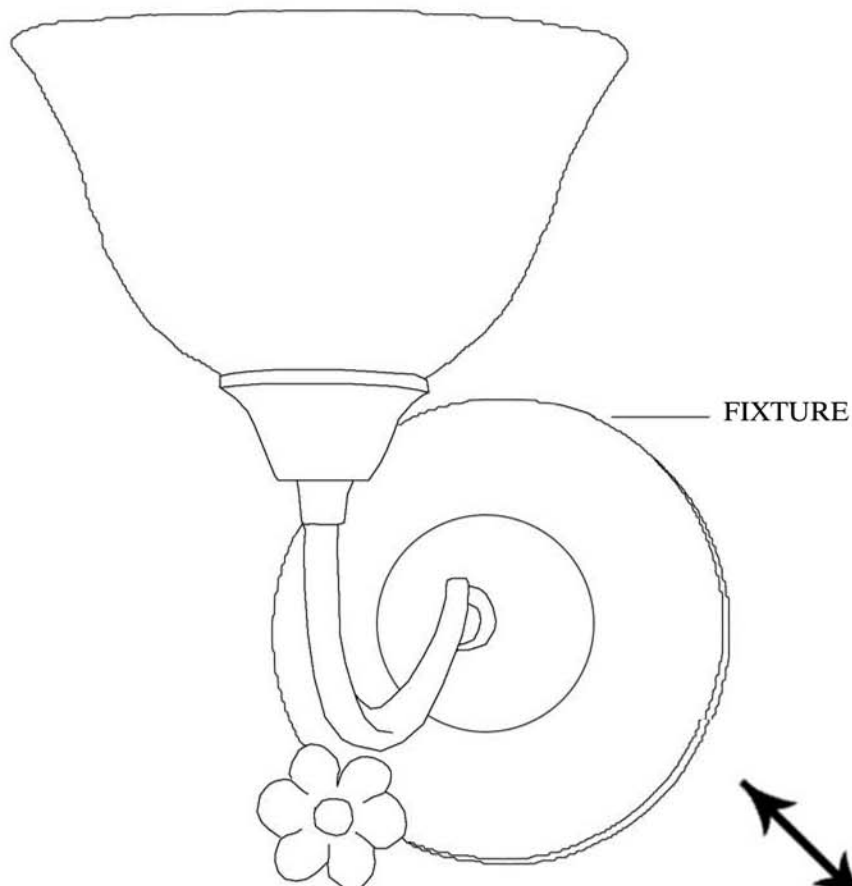

"A Commitment to Excellence in Lighting and Service"

CALL OUR CUSTOMER SERVICE DEPARTMENT AT 1-800-222-4009

MONDAY - FRIDAY 8:00 a.m. - 6:00 p.m. ET

visit us on the web at www.meyda.com