

ASSEMBLY INSTRUCTIONS FOR 29531 (Q331WBH-12-144)

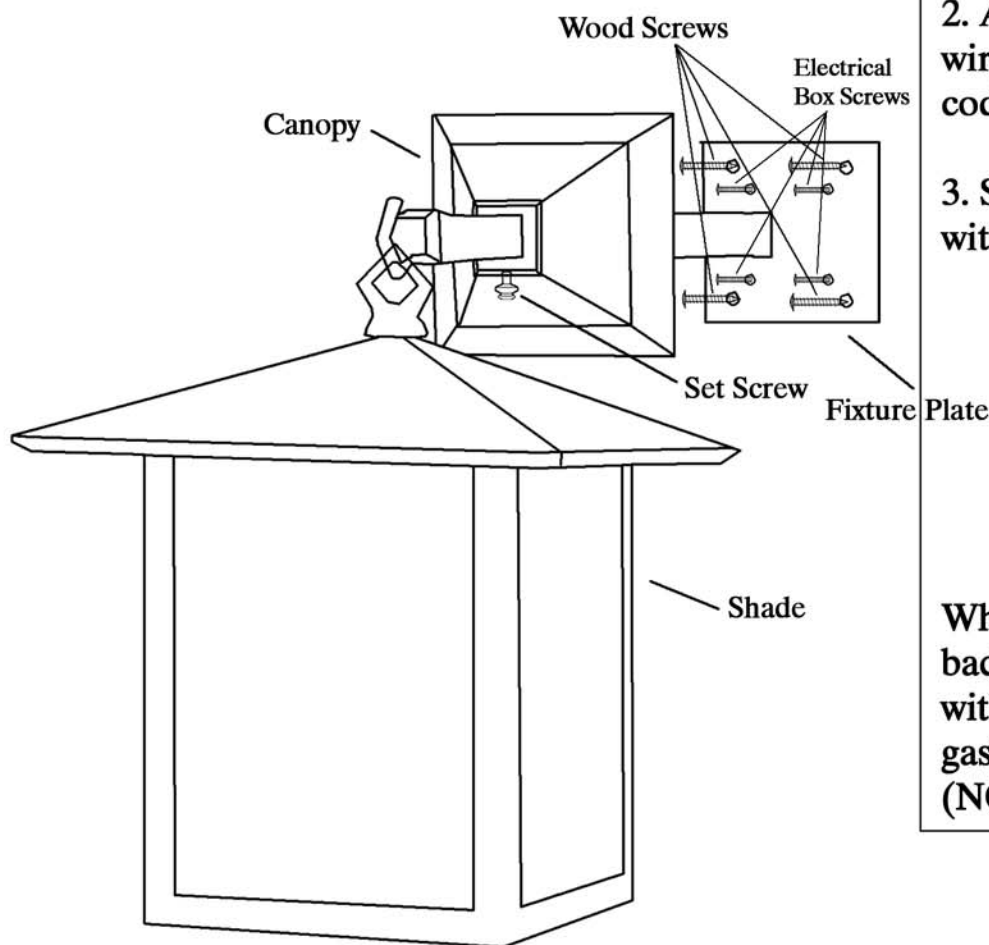
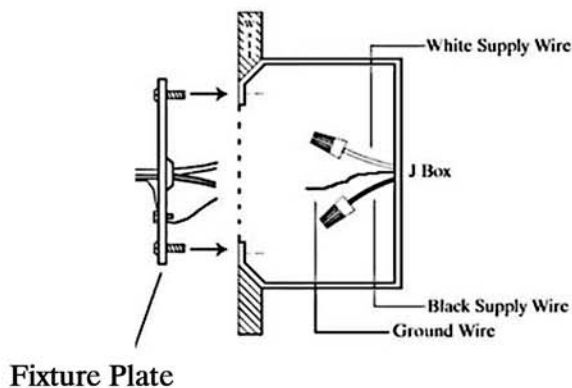

IMPORTANT

TURN OFF THE POWER AT THE MAIN FUSE OR CIRCUIT BREAKER BOX BEFORE STARTING INSTALLATION

CAREFULLY UNPACK AND IDENTIFY ALL PARTS BEFORE ASSEMBLY. BULBS ARE NOT INCLUDED

1. Attach fixture with fixture plate to J-box with electrical box screws.
2. Attach fixture wires to JBox wires (wire as per local electrical code).
3. Slide canopy to wall and secure with set screw.

NOTE

When sconce is used in wet location backplate must be sealed to wall with Neoprene Rubber or Rubber gasket, or Silicone Rubber Sealant (NOT SUPPLIED).



"A Commitment to Excellence in Lighting and Service"

CALL OUR CUSTOMER SERVICE DEPARTMENT AT 1-800-222-4009

MONDAY - FRIDAY 8:00 a.m. - 6:00 p.m. ET

visit us on the web at www.meyda.com