

ASSEMBLY INSTRUCTIONS FOR #134833

FIG. A

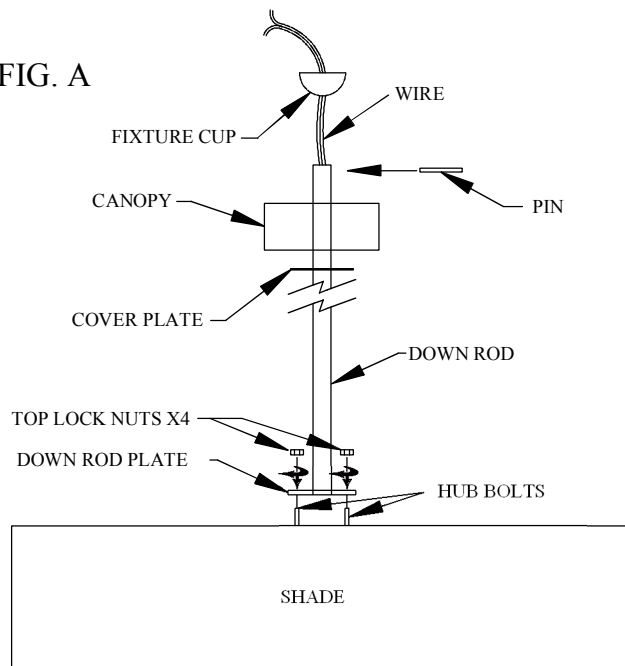

FIG. B

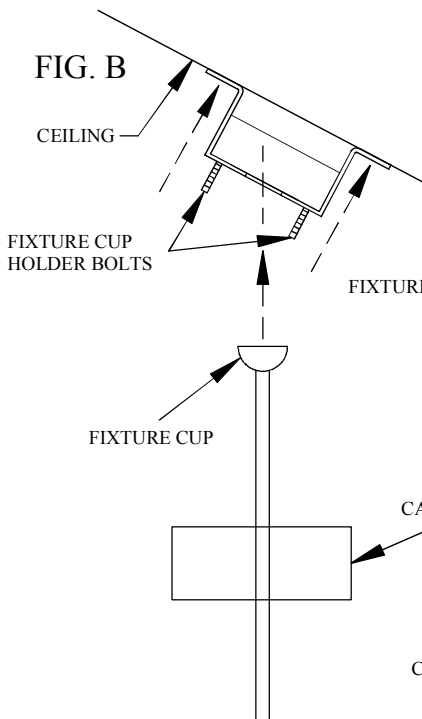
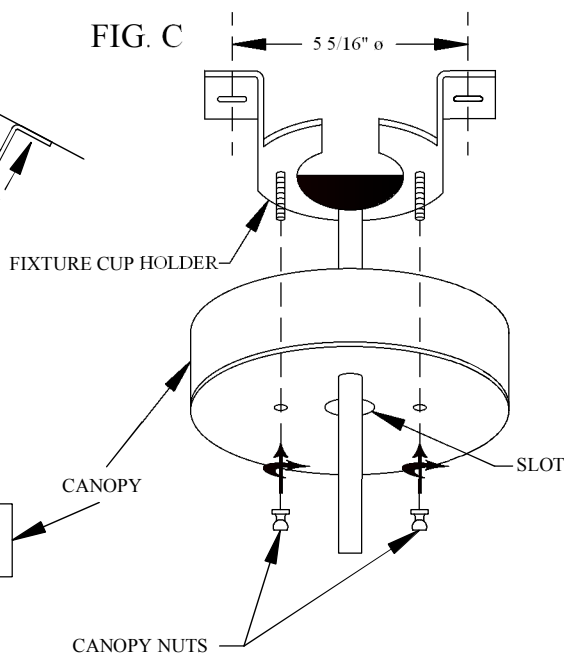

FIG. C



IMPORTANT

TURN OFF THE POWER AT THE MAIN FUSE OR CIRCUIT BREAKER BOX BEFORE STARTING INSTALLATION

CAREFULLY UNPACK AND IDENTIFY ALL PARTS BEFORE ASSEMBLY. BULBS ARE NOT INCLUDED

THIS FIXTURE WEIGHS OVER 50 LBS. NEC:314.27B, A luminaire that weighs more than 23kg (50lb) shall be supported independently of the outlet box unless the outlet box is listed AND MARKED for the MAXIMUM weight supported.

THIS IS A TWO PERSON JOB

- 1.) ATTACH FIXTURE CUP HOLDER TO A SECURE LOCATION USING FASTENERS SUPPLIED BY OTHERS. FIG. B
- 2.) FEED WIRES THROUGH DOWN ROD. PLACE DOWN ROD PLATE ONTO HUB BOLTS (4) AND TIGHTEN WITH LOCK NUTS PROVIDED FIG. A.

FOR SLANTED CEILING

- 3.) SLIDE CANOPY ONTO DOWN ROD FIG. A
- 4.) PLACE FIXTURE CUP ONTO DOWN ROD. INSERT PIN INTO END OF DOWN ROD MAKING SURE PIN IS CENTERED TO ENSURE PROPER SEATING INTO FIXTURE CUP. FIG. A
- 5.) HANG FIXTURE BY SLIDING FIXTURE CUP THROUGH SLOT IN FIXTURE CUP HOLDER. FIG. B
- 6.) WIRE AS PER LOCAL ELECTRICAL CODES.
- 7.) ATTACH CANOPY FASTENING WITH CANOPY NUTS PROVIDED. FIG. C

FOR FLAT CEILING

- 8.) FEED WIRES THROUGH DOWN ROD. PLACE DOWN ROD PLATE ONTO HUB BOLTS (4) AND TIGHTEN WITH LOCK NUTS PROVIDED FIG. A.)
- 9.) SLIDE COVER PLATE THEN CANOPY OVER DOWN ROD. FIG. A
- 10.) PLACE FIXTURE CUP ONTO DOWN ROD. INSERT PIN INTO END OF DOWN ROD MAKING SURE PIN IS CENTERED TO ENSURE PROPER SEATING INTO FIXTURE CUP. FIG. A
- 11.) HANG FIXTURE BY SLIDING FIXTURE CUP THROUGH SLOT IN FIXTURE CUP HOLDER. FIG. B
- 12.) WIRE AS PER LOCAL ELECTRICAL CODES.
- 13.) ATTACH CANOPY AND COVER PLATE, FASTENING WITH CANOPY NUTS PROVIDED. FIG. C.

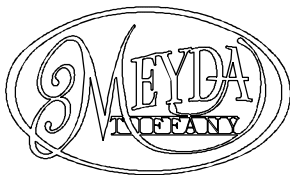

"A Commitment to Excellence in Lighting and Service"

CALL OUR CUSTOMER SERVICE DEPARTMENT AT 1-800-222-4009

MONDAY - FRIDAY 8:00a.m - 6:00p.m ET

visit us on the web at www.meyda.com



specifications
"A Commitment to Excellence in Lighting and Service"

CALL OUR CUSTOMER SERVICE DEPARTMENT AT 1-800-826-1602

MONDAY - FRIDAY 8:00a.m - 6:00p.m ET

visit us on the web at www.meyda.com

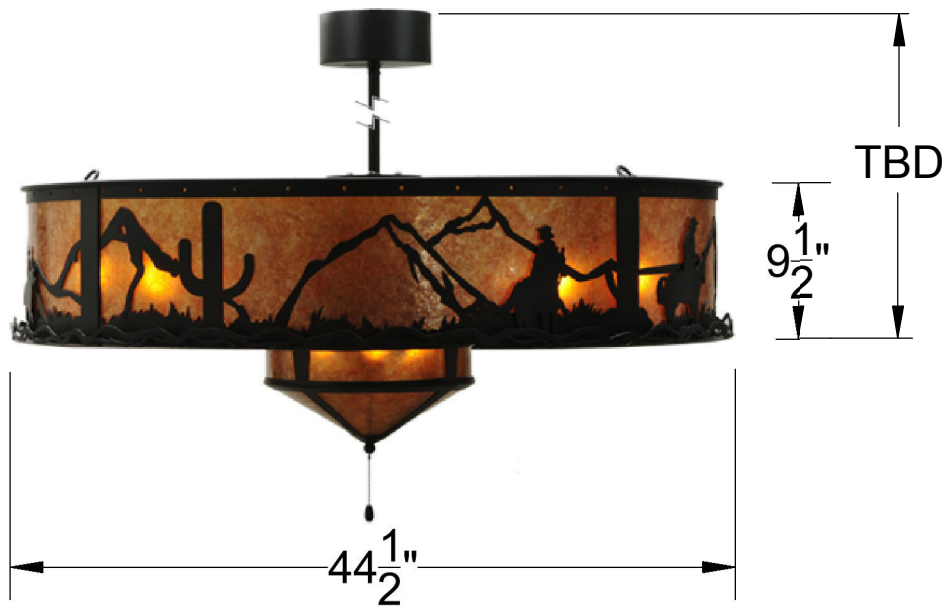

*DIMENSIONS AND DETAILS ARE SUBJECT TO MODIFICATION DURING PRODUCTION
 © MEYDA TIFFANY INC © DESIGN COPYRIGHT, MEYDA TIFFANY, INC. ALL RIGHTS RESERVED, NO UNAUTHORIZED DUPLICATION



ITEM# 134833	EMP #	BULB# 8	EMP #	LOCATION:	
DESIGN#	EMP #	TYPE:	EMP #	HG	Date: 06/22/2012
FIXTURE TYPE: CHANDEL-AIR	EMP #	WATT:	EMP #	DIMENSIONS/NOTES:	
LENS COLOR: AMBER MICA	EMP #	VOLTAGE: 120	EMP #	APPROVAL	
FINISH: BLACK	EMP #	MATERIAL:		WEIGHT: 70 LBS	

Fan Specifications

integrating the best of both worlds, Chancel-Air incorporates custom lighting design with fan technologies. Form and function presented beautifully. Designed for ceilings of any pitch or height. Dimming capabilities included. Fan specifications listed below.

Features

- Standard, 3 Speed Reversible motor
- 2" and 6" Down rods (included)
- 30 year limited warranty
- Custom 29" Piccolo Blades Sold Separately
- Light Kit Adaptable (optional)
- Universal Control Adaptable (UC-2000) (Optional)
- Great for Small Spaces

Specs

Blade Sweep	29"
Number of Blades	5
Blade Pitch	25°
Motor Size (MM)	153 x 8
AMPS (HI Speed)	0.4
Watts (HI Speed)	46
RPM (HI-MED-LOW)	200-120-55
Shipping Wt. (lbs.)	13.71
CU. FT in Carton	1
Airflow*	2,287 (Cubic Feet Per Minute)
Airflow Efficiency*	50 (Cubic Feet Per Minute Per Watt)

Ceiling Drop Dimensions

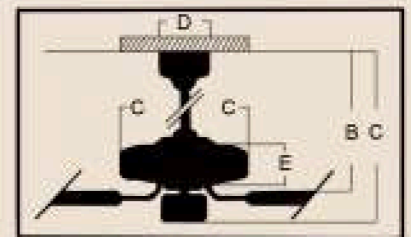

A: 2" DR - 10.25"	B: 2" DR - 8.0"
A: 6" DR - 14.25"	B: 6" DR - 12.0"
C: 9.0"	D: 5.875"
E: 3.25"	

DR: Down rod

* Compare 36" to 48" ceiling fans have air-flow efficiencies ranging from approximately 71 to 86 cubic feet per minute per watt at high speed.

Available Finishes



AW-Antique White

BN-Brushed Nickel

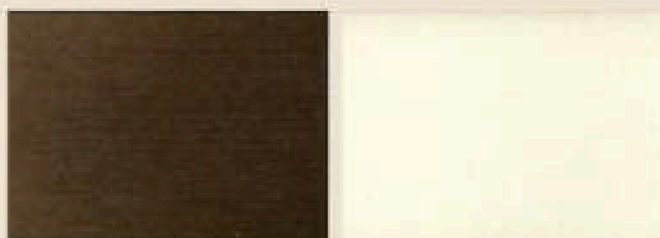

OB-Oiled Bronze

W-White

Blade Options

Model Specific: Available in AW (Antique White), BN (Brushed Nickel), DOK (Dark Oak), LOK (Light Oak), OB (Oiled Bronze) and W (White)

Light Kit Options

Bowl Light Kits Complete Light Kit Customize Your Own



Remotes



Universal Remote Control System
(optional)
UC 2000 2